

SR124

PERFORMANCE CRITERIA FOR SR124 STATIC BLOWER/EXHAUSTER

For correct operation of this unit, the following maximum conditions must not be exceeded :-

Speed	3500 rev/min
Pressure difference across unit	550 mbar
Pressure ratio across unit	1.65
Temperature rise across unit	140 deg C
Outlet temperature	170 deg C
Inlet temperature	50 deg C
Belt pull	2930 N dynamic

This unit must not be run at speeds less than those given below (blower sea level pressure difference in brackets):

800 rpm at press. ratios up to 1.65	(550 mbar)
1000 rpm at press. ratios from 1.65 to 2.0	

$$\text{Pressure ratio} = \frac{\text{Absolute outlet pressure}}{\text{Absolute inlet pressure}}$$

Normal (sea level) ambient conditions are 1013 mbar & 15 deg C.

A BLOWER is a unit in which the inlet pressure is substantially equal to the ambient pressure.

An EXHAUSTER is a unit in which the inlet pressure is significantly below the ambient pressure, although the outlet pressure might be above the ambient (as in "suck-blow" application).

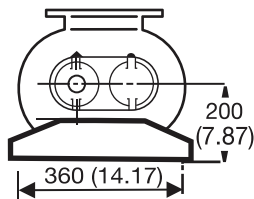

VERTICAL AIRFLOW BLOWER
(for other dimensions see below)

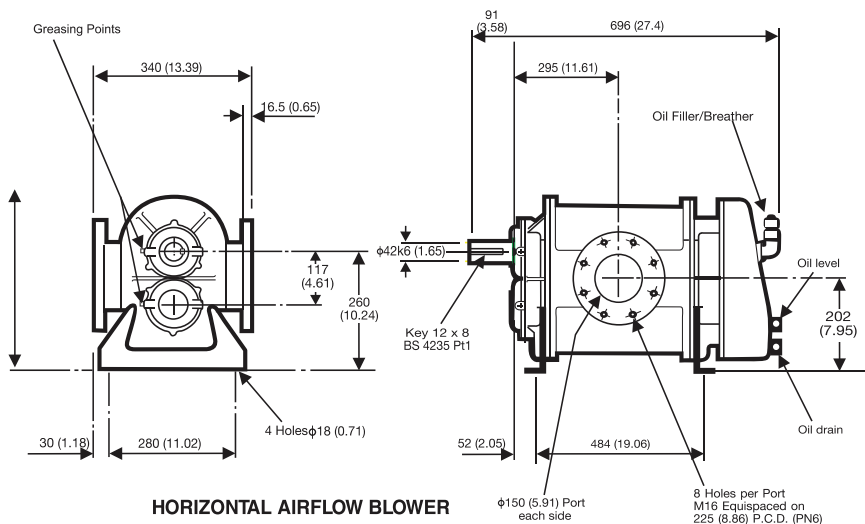

HORIZONTAL AIRFLOW BLOWER

Weight 138kg (304lbs)

Dimensions in millimetres (inch conversions in brackets)

UNIQUE FEATURES

- * Rotors of cycloidal form with carbon tip inserts for maximum airflow, maximum efficiency and fuel saving.
- * Longitudinal dowelling of gears and rotors to eliminate any possibility of movement or loss of synchronisation.
- * Pre-dowelled gears and rotors to ensure accurate and automatic phasing whenever these parts are changed eliminating the need for specialised fitting techniques which are normally required during re-assembly of a Roots type blower.

STANDARD FEATURES

The blower can be driven clockwise or anti clockwise and is suitable for direct coupling or vee belt drive throughout the performance range.

All units are built for universal mounting, the appropriate bolt on feet are supplied for the airflow required.

Freely vented air gaps between the air chamber and the lubricating system eliminate any possibility of the blower lubricant contaminating the airflow.

SR124 blowers and exhausters can be supplied as bareshaft units or complete with motor, transmission equipment, baseplate, filters, silencers and a full range of accessories to meet requirements and duties specified.

SPECIFICATION

Casing: The main case and bearing housings are manufactured from high quality grey cast iron.

Rotors: The rotors and shafts of ample rigidity and strength are cast integrally in high tensile spheroidal graphite iron. They are machined all over which ensures vibration free operation.

Bearings: Grease lubricated single row roller bearings are used on the drive end of the blower. At the gear end, an oil lubricated double row angular contact ball bearing supports each shaft radially as well as providing axial location of the rotors.

Gears: Oil lubricated straight spur timing gears are hardened and ground for accuracy, long life and lowest possible mechanical noise level.

.....
All blowers are individually tested. Test certificates will be issued if requested.

A comprehensive Installation and Operating Instruction folder is supplied with every blower.